

Vibranivo®

**Serie
VN 4000**

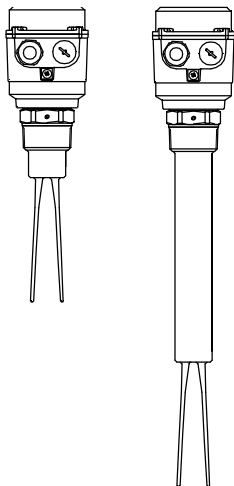

Mononivo®

**Serie
MN 4000**

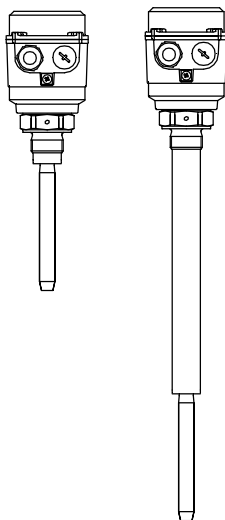

Istruzioni d'uso

010516

UWT GmbH
Westendstraße 5
D-87488 Betzigau

Tel.: +49 (0)831 57123-0 Internet: www.uwt.de
Fax: +49 (0)831 76879 E-Mail: info@uwt.de

Queste istruzioni d'uso sono valide per:	Tipi	VN 4020 4030 MN 4020 4030
	Omologazione	CE / TR-CU ATEX 1/2D IEC-Ex t IIIC
	Moduli elettronici	Relè (DPDT) PNP

Indice

Avvertenze di sicurezza/pericoli	Pagina	4
Utilizzo	Pagina	4
Dati tecnici	Pagina	4
Impiego	Pagina	11
Montaggio	Pagina	13
Parti di ricambio	Pagina	18
Conessioni elettriche	Pagina	19
Logica di commutazione	Pagina	21
Manutenzione	Pagina	22
ATEX / IEC-Ex Hinweise	Pagina	23

Avvertenze di sicurezza/pericoli

Installazione, manutenzione e messa in funzione devono essere eseguite esclusivamente da apposito personale specializzato.

Per effettuare l'allacciamento elettrico devono venire rispettate le prescrizioni locali o la norma VDE 0100.

Tutti i cavi di connessione devono essere isolati per una tensione d'esercizio di almeno 250 V CA. Resistenza alle alte temperature: min. 90°C (194°F).

La sicurezza non è garantita in caso di uso improprio dell'apparecchio.

Utilizzo





Interruttore limitatore per la misurazione del livello in materiali sfusi in polvere o granulati.

Dati tecnici

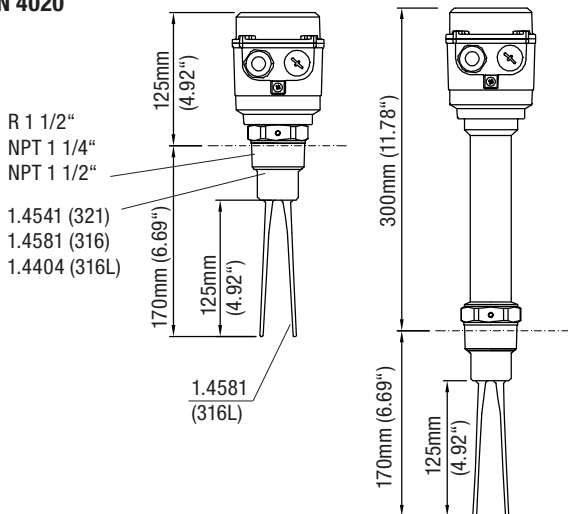

VN 4020



	① → 	② → 
	-1 .. +16bar (-14.5 .. +232psi)	-1 .. +16bar (-14.5 .. +232psi)
	~ 1,7kg (3.7 lbs)	~ 2,4kg (5.3 lbs)

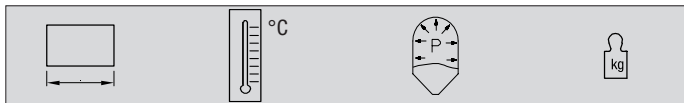

VN 4030

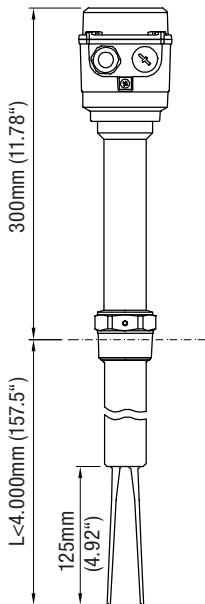
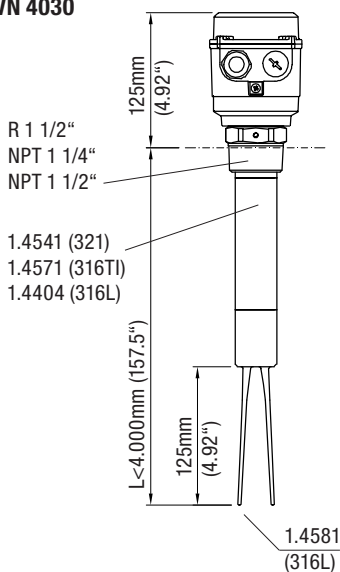

	① / ② → ⑨	② → ⑨
	-1 .. +16bar (-14.5 .. +232psi)	-1 .. +16bar (-14.5 .. +232psi)
	~1,7kg (3.7lbs) +1,9kg/m (+4.2 lbs per 39.9" (L))	~2,4kg (5.3lbs) +1,9kg/m (+5.5 lbs per 39.9" (L))



MN 4020

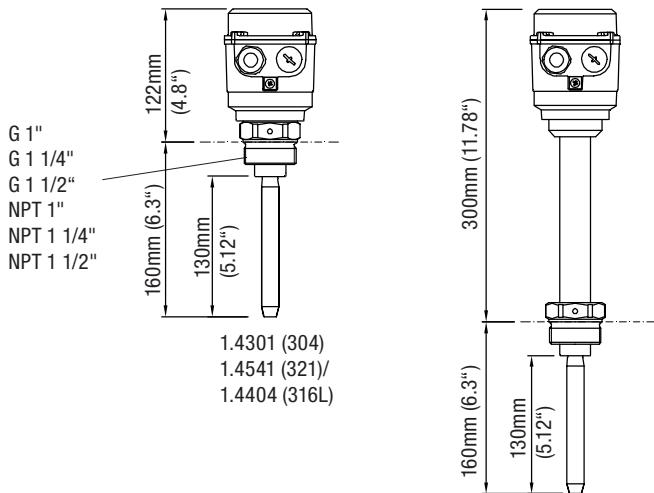

	① →	② →
	-1 .. +16bar (-14.5 .. +232psi)	-1 .. +16bar (-14.5 .. +232psi)
	~ 1,3kg (2.9 lbs)	~ 2,0kg (4.5 lbs)

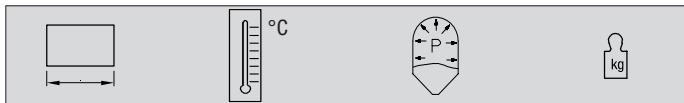

MN 4030

G 1"
 G 1 1/4"
 G 1 1/2"
 NPT 1"
 NPT 1 1/4"
 NPT 1 1/2"

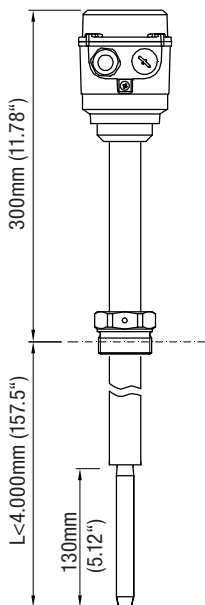
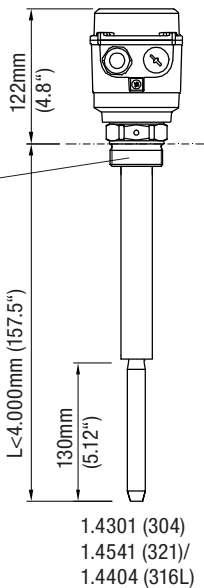

	① / ② → ⑨	② → ⑨
	-1 .. +16bar (-14.5 .. +232psi)	-1 .. +16bar (-14.5 .. +232psi)
	~1,3kg (2.9lbs) +1,3kg/m (+2.9 lbs per 39.9") (L)	~2,0kg (4.5lbs) +1,3kg/m (+2.9 lbs per 39.9") (L)

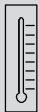

°C

1

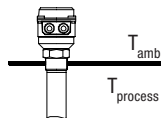
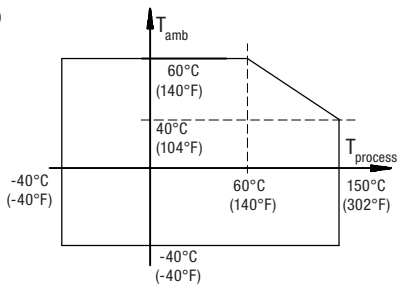

2

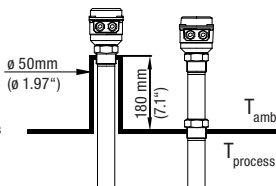
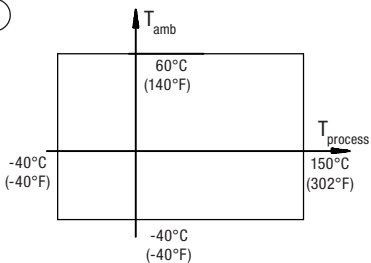

Sensibilità

VN 4000

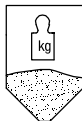

>30 g/l	B
>150 g/l	A

$$1\text{g/l} = 0.06 \text{ lb/ft}^3$$

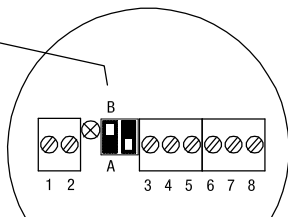

MN 4000

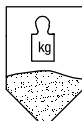

>20 g/l	
>80 g/l	
>150 g/l	
>300 g/l	

$$1\text{g/l} = 0.06 \text{ lb/ft}^3$$

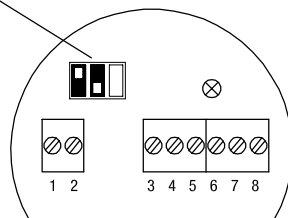

Tipo di materiale sfuso

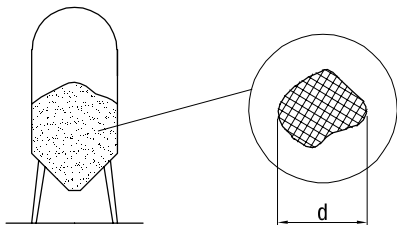

VN 4000:
 $d < 8\text{mm}$ (0.31")

MN 4000:
 $d < 20\text{mm}$ (0.79")

Installazione

VN 4020
MN 4020

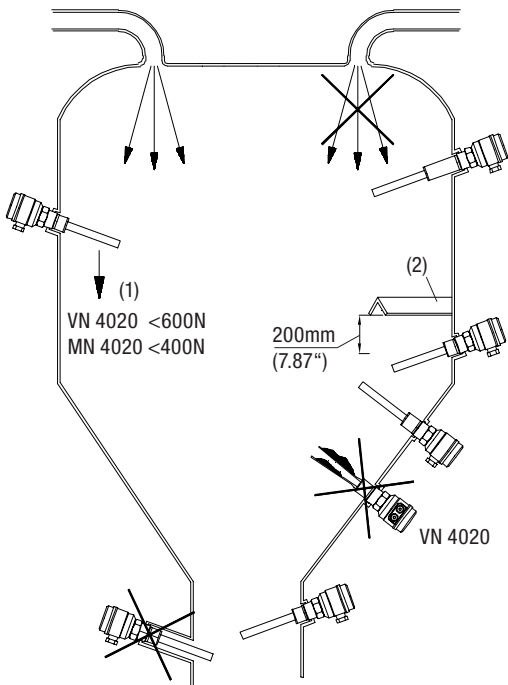

- (1) Carico mec. del sistema oscillante
- (2) Angolare in acciaio per forze meccaniche elevate

VN 4030
MN 4030

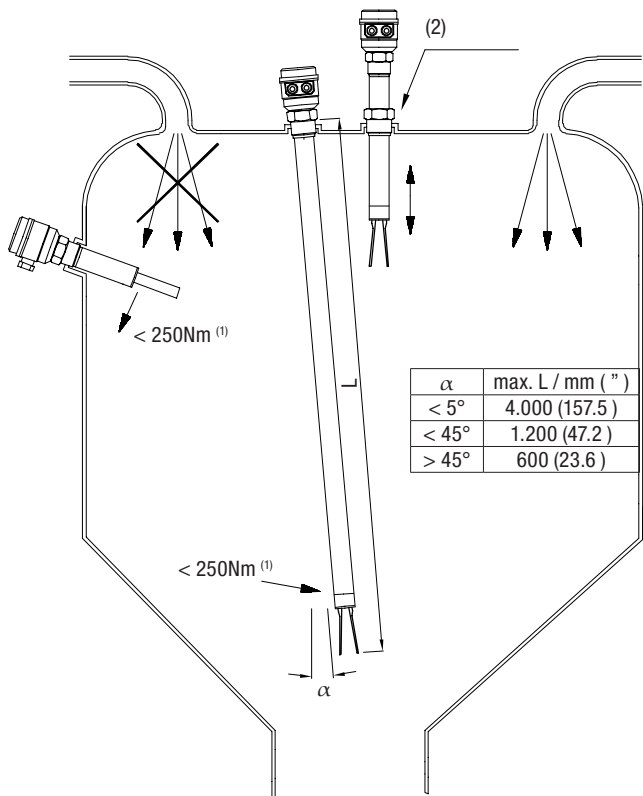

(1) Carico mec. del sistema oscillante

(2) Manicotto sincronizzatore: vite di serraggio con 20Mn

Montaggio

Fissaggio Filetto

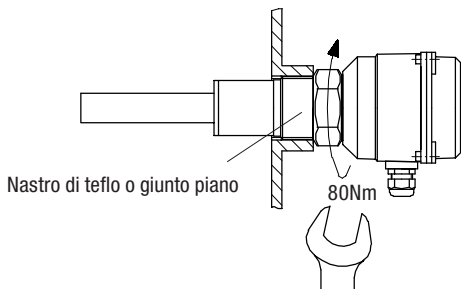

Fissaggio Flangia

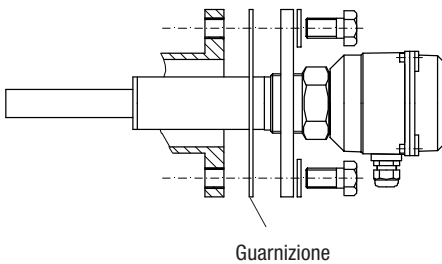

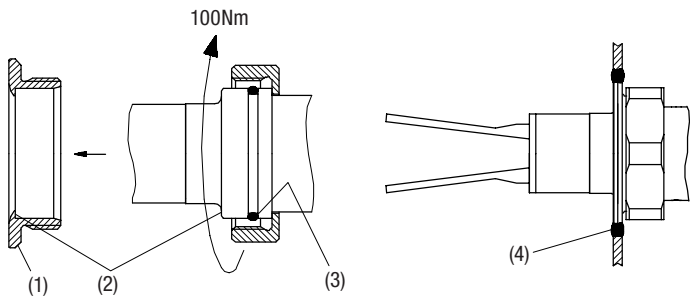

- (1) Manicotto a saldatura certificato prescritto
- (2) Metallo-placcatura non fissile
- (3) Anello di tenuta
- (4) Saldatura (osservare le norme igieniche)

Allineamento

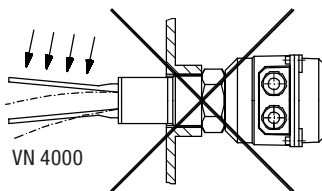
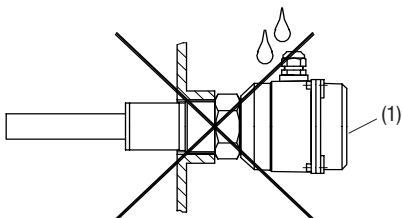
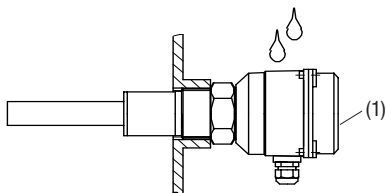

(1) Grado di protezione IP 66

VN 4000

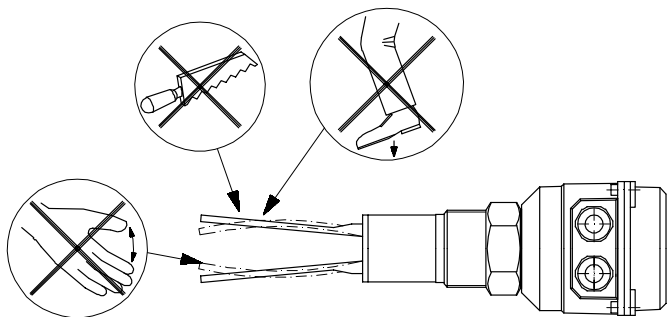

MN 4000

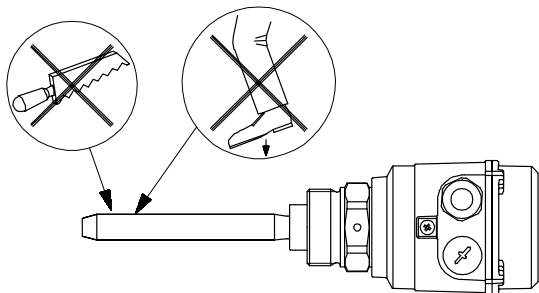

Opzione: Calotta di protezione contro le intemperie

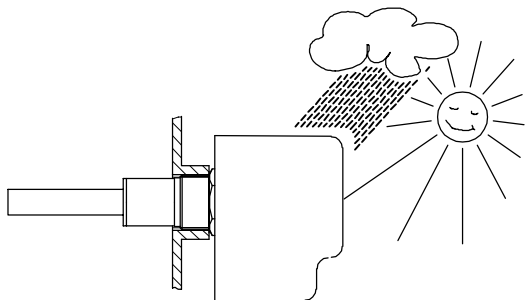

per Ex omologato solo per zona 22

Parti di ricambio

VN 4000

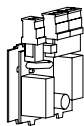

19...230V 50/60 Hz 19...40V DC	pl408265
18...50V DC PNP	pl408266

MN 4000

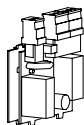

21...230V 50/60 Hz 22...45V DC	pl405265
18...50V DC PNP	pl405266

Connessione elettrica

Tutti i moduli elettronici: Categoria di sovratensione II

Relè DPDT

VN 4000
MN 4000

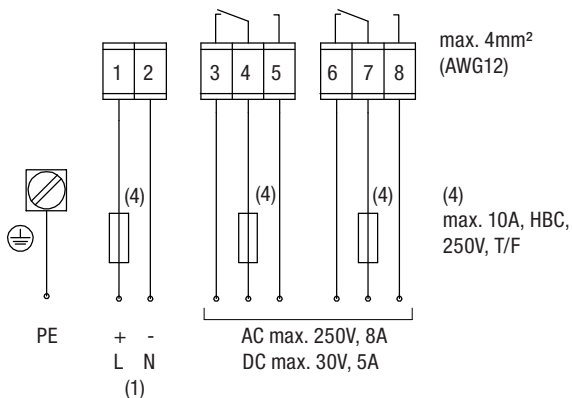

(1)

VN 4000: 19...230V $\pm 10\%$ ⁽³⁾ 50-60Hz 22VA 19... 40V $\pm 10\%$ ⁽³⁾ DC 2W

MN 4000: 21...230V $\pm 10\%$ ⁽³⁾ 50-60Hz 22VA 22... 45V $\pm 10\%$ ⁽³⁾ DC 2W

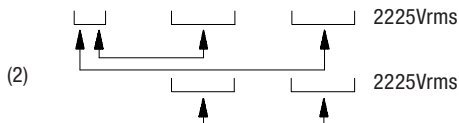

(1) Tensione di alimentazione

(2) Tensione isolante

(3) incluso 10% da EN 61010

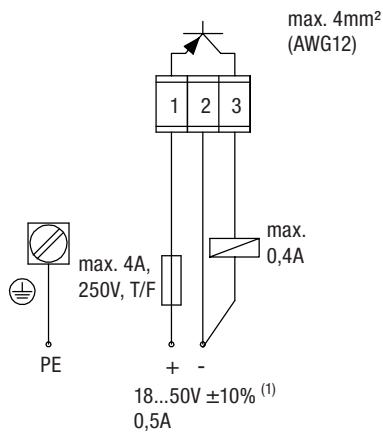
VN 4000
MN 4000

(1) Tensione di alimentazione, incluso 10% da EN 61010

VN 4000

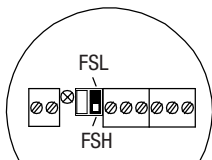

MN 4000

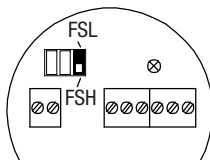

	FSL	FSH	
			(1)
			(2)
			(1)
			(2)

(1) = Relè DPDT

(2) = PNP

VN 4000

MN 4000

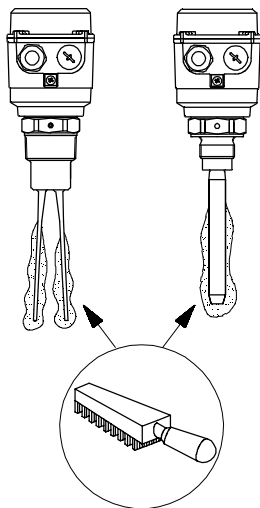

ATEX II 1/2D + IEC-Ex t IIIC Da/Db

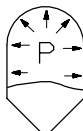

Note

Pressione relativa consentita



-0,2...+0,1bar
(-2.9...+1.45psi)

Limiti ammessi

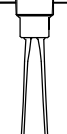
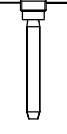
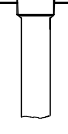
	VN 4020	MN 4020	VN 4030 MN 4030
(1) 2D			
(2) Db			
(3) 21			
(1) 1D			
(2) Da			
(3) 20			

(1) Categoria (2) EPL (IEC-Ex) (3) Zona

Temperatura ambiente

temperatura max. superficie



VN 4000
MN 4000

60°C (140°F)	110°C (230°F) 120°C (248°F) 130°C (266°F) 140°C (284°F) 150°C (302°F)	115°C (239°F) 120°C (248°F) 130°C (266°F) 140°C (284°F) 150°C (302°F)
-----------------	---	---

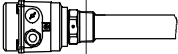
A technical drawing showing a cross-section of the probe tip, which is cylindrical with a flat end and a small hole in the center.

Installazione

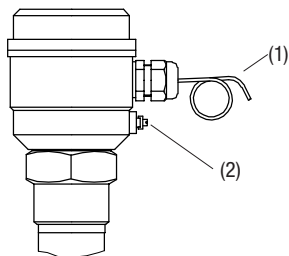

- (1) prevedere uno scarico della trazione meccanica
- (2) Collegare alla compensazione del potenziale

Per l'installazione e l'allacciamento si devono rispettare le norme vigenti nel Paese dell'installatore.

La messa in funzione va effettuata solo ad apparecchio chiuso.

L'apparecchio può essere aperto solo in assenza di tensione.

Prima dell'apertura, verificare che non siano presenti accumuli di polvere o materiali trascinati dalle palette.

Il montaggio dev'essere effettuato in modo tale da escludere la produzione di scintille, dovuta a procedimenti di percussione o strofinamento, tra il contenitore in alluminio e l'acciaio.

Collegamento cavi:

L'esecuzione deve rispettare le normative del paese dove verrà installato l'apparecchio.

Punti di inserzione dei cavi non utilizzati devono essere chiusi con gli appositi otturatori.

Nei limiti del possibile utilizzare le parti fornite dal produttore.

Per quanto riguarda i collegamenti a vite per cavi forniti dal produttore è necessario prevedere uno scarico della tensione.

Il diametro dei cavi di collegamento deve essere idoneo all'area dei morsetti del collegamento a vite.

In caso venissero utilizzate parti diverse di quelle fornite dal produttore, assicurarsi che:

le parti siano dotate di omologazione, idonea all'omologazione dell'indicatore di livello (certificato e tipo di protezione).

La temperatura d'esercizio autorizzata deve corrispondere alla temperatura d'ambiente minima del rilevatore di livello e alla temperatura d'ambiente massima + 10 Kelvin del rilevatore di livello.

Le parti vanno montate in base alle indicazioni del libretto d'istruzioni fornito dal produttore.